

NOVA LED Street Light



Areas of application

- Local roads
- Express roads
- Town roads
- Residential area roads
- Pedestrian crossings
- Parking areas



Product Benefits

- 70% energy saving, short ROI period
- Up to 100,000hrs @ L70, low maintenance cost
- Wide choice of optics for different applications
- Smart design, low transportation costs
- Smooth back of fixture is designed to prevent dust accumulation
- 5 years warranty

Product Features

- Luminaire efficacy: Up to 140 lm /w
- Lifetime more than 100,000 hours
- Impact resistance: IK10
- Type of protection: IP66



Product Datasheet

Version S

Model No		ZGSM-ST18-30S	ZGSM-ST18-40S	ZGSM-ST18-50S
Nominal Wattage		30W	40W	50W
3030 Version	Efficiency Lumen	130 lm /w 3900 lm	130 lm /w 5200 lm	130 lm /w 6500 lm
5050 Version	Efficiency Lumen	140 lm /w 4200 lm	140 lm /w 5600 lm	140 lm /w 7000 lm

Version M

Model No		ZGSM-ST18-60M	ZGSM-ST18-80M	ZGSM-ST18-100M
Nominal Wattage		60W	80W	100W
3030 Version	Efficiency Lumen	130 lm /w 7800 lm	130 lm /w 10400 lm	120 lm /w 12000 lm
5050 Version	Efficiency Lumen	140 lm /w 8400 lm	140 lm /w 11200 lm	130 lm /w 13000 lm

Version L

Model No		ZGSM-ST18-120L	ZGSM-ST18-150L
Nominal Wattage		120W	150W
3030 Version	Efficiency Lumen	130 lm /w 15600 lm	130 lm /w 19500 lm
5050 Version	Efficiency Lumen	140 lm /w 16800 lm	140 lm /w 21000 lm

*Above values are calculated based on the product with CCT over 3000K, and values of 3000K are 5% lower than above values.
 *Values shown are subject to $\pm 5\%$ tolerance.

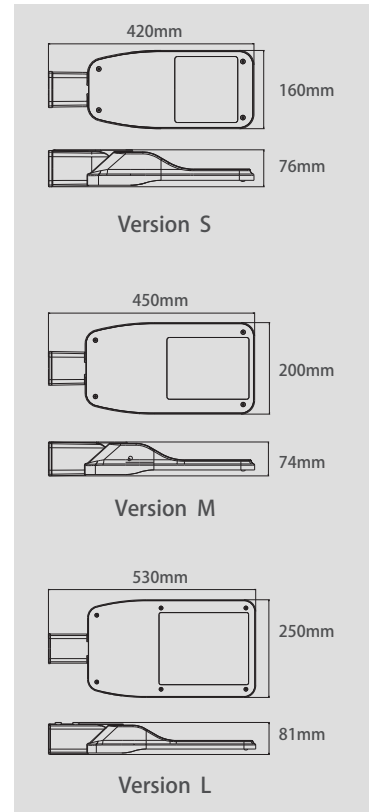

Dimension:

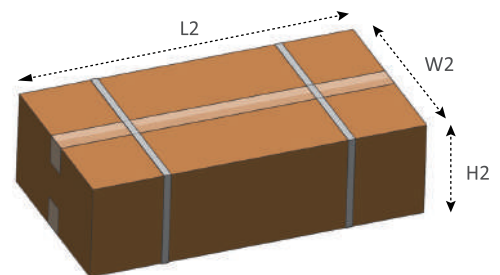
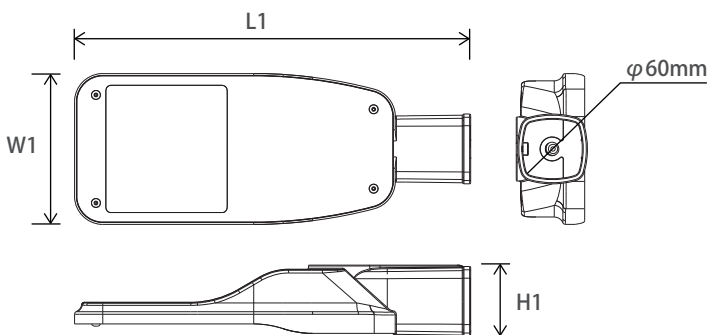

Fixture Information

Version	L1 xW1 xH1	Weight
S	420 x160 x76mm	2.0kg
M	450 x200 x74mm	2.6kg
L	530 x250 x81mm	3.8kg

Package Information

Version	L2 xW2 xH2	Weight
S	425 x165 x135mm	2.3kg
M	455 x205 x135mm	2.9kg
L	535 x255 x135mm	4.3kg

Product Datasheet

Electrical Data:

Nominal Voltage	AC 100-240V /277V 50 /60Hz
LED	Bridgelux /Other brands on request
Driver	DONE /Other brands on request
Power Factor (PF)	>0.90
THD	<15
SPD	10KV (Default) / 20KV (available on request)
Optics	Type II, Type III
Standard Deviation of Color Matching	<5 SDCM
CRI	Ra>70 (Default) / Ra>80
CCT	3000K, 4000K, 5000K, 5700K

General Data

Body Material	High pressure die-cast aluminum
Housing Color	Gray (Default) /Black (available on request)
Cover Material	Tempered glass
Lens Material	UV-resistant Polycarbonate
Working Environment	-40° C ~ +50° C, 10%Ø0%RH
Lifespan L70 at 25 ° C	>100, 000 h
Mounting Type	Side entry
Dimmable	Non-dimming (Default) /1-10v(available on request)
Protection Class	Class I (Default) /Class II
Standards	CE, RoHS, LM79, LM80, TM-21, IP66, IK10
Available on request	NEMA socket (3/5/7pins), ZHAGA socket, Short cap, Photocell, Motion sensor, NTC, OLC, Solar Compatible, 1-10V/DALI Dimming

Optional accessories

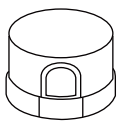

Photocell



Short Cap



NEMA Socket
(3 /5 /7pin)

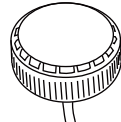

Motion Sensor



Smart Controller

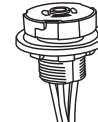

ZHAGA Socket

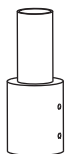

"80-60mm"



"60-40mm"

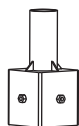

Square to round

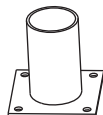

"T" Type

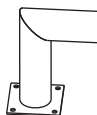

"L" Type

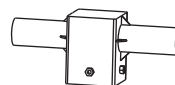

"2" in "1"

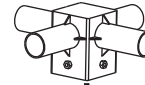

"4" in "1"

Product Datasheet

Light Distributions

Order reference

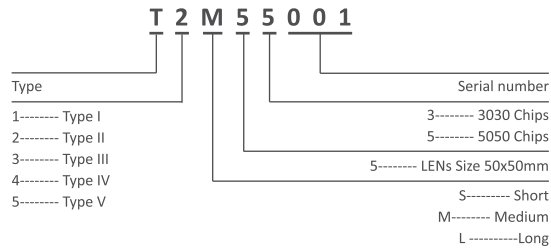

3030 Version

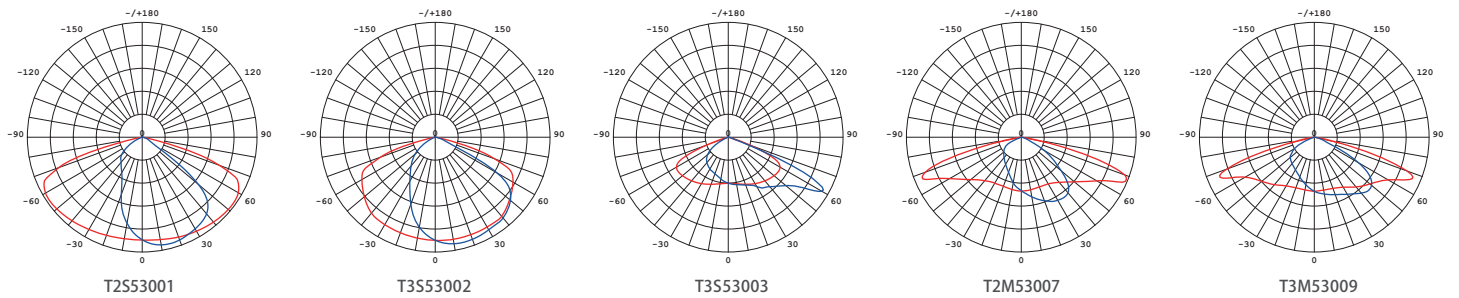

5050 Version

